



Nice

andez  
grifería y accesorios

## ATRIBUTOS



### **CROMADOS MÁS BRILLANTES**

Alto espesor y dureza



### **AIREADOR ESPUMANTE**

Menos consumo de agua,  
igual sensación



### **CIERRE CERÁMICO**

Aprobaciones internacionales,  
procede de España



### **SISTEMA ANTIMOVIMIENTO**

Más firme, mejor control



### **LATERALES AUTONIVELANTES**

No necesita ajustes posteriores



### **FLOR DE DUCHA CON ANTISARRO**

De silicona



### **VOLANTES CON GRIP SOFT TOUCH**

Sensación suave



### **DISTINCIÓN OFICIAL**

Sello Buen Diseño  
Argentino





LAVATORIO  
NICE  
500.50.04

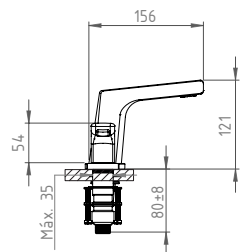
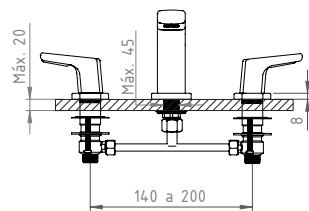
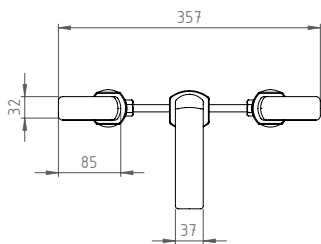

BAÑERA XXL  
NICE  
604.50.04

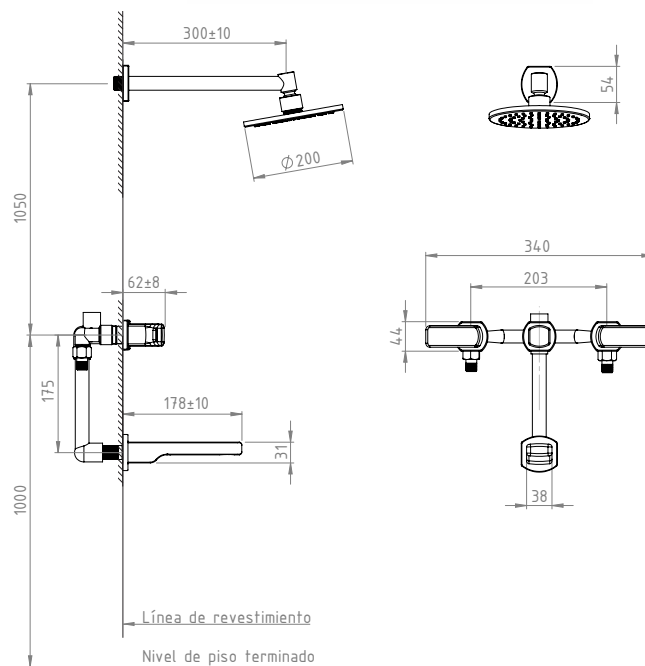

BIDET  
NICE  
700.50.04

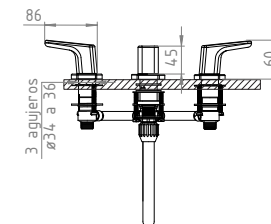
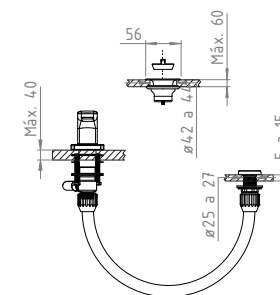
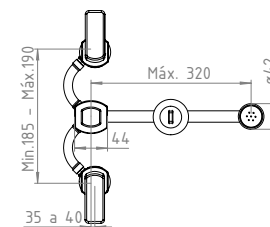





andez  
grifería y accesorios

[www.andez.com.ar](http://www.andez.com.ar)

@andezgriferia